

## Assessment of Matrix variation of Nuclear Materials bearing samples on gamma ray detector response using MCNP code

M. Darweesh

*Safeguards & Physical Protection Department, Egyptian Nuclear and Radiological Regulatory Authority,  
P.O.Box 7551, Nasr City, 11762 Cairo, Egypt*

### -----ABSTRACT-----

Careful verification of the quantities of nuclear material is required during the various stages of the life of the nuclear fuel cycle facilities for nuclear safeguard activities. The nuclear fuel cycle contains a different matrix of nuclear materials with different densities as well as in their chemical composition that may affect the response of gamma ray detectors. Relative measurement using gamma ray detectors is a good tool for checking the content of nuclear materials. This method requires different standard sources for calibration of the measurement system. Which may be difficult to obtain. In this work, various compounds of uranium, thorium, and plutonium have been proposed to study the effect of variance in the nuclear material matrix on the response of the HPGe detector using MCNP. The simulation involves modeling the germanium detector calculated as the "F8" pulse height in common gamma ray power lines using the MCNP code for the proposed samples.

**KEYWORDS;** -MCNP, Detector response, Nuclear safeguards, nuclear material

Date of Submission: 11-05-2020

Date of Acceptance: 22-05-2020

### I. INTRODUCTION

In a country with nuclear activities, a system of controlling nuclear material is considered as an essential requirement. The main goal of such system is to make sure that nuclear material and activities in state are utilized as planned and not diverted for non-peaceful uses or misused [1]. Part of controlling system is a measurement system that must have the capability to verify all types and categories of nuclear materials exist in the nuclear fuel cycle in state. To verify the nuclear material, it has to be measured using a suitable device [2]. Nuclear materials are usually measured using gamma-ray spectrometer in order to quantify certain isotopes [3]. Accurate measurements of radioisotopes-bearing samples are usually performed using relative methods. In such methods the radiation emitted from the assayed samples are measured by utilizing a previously calibrated radiation detector using standard materials. Due to the wide variety of the assayed samples; typically, calibration standards with identical characteristics to the assayed samples are not usually available. Consequently, the quality of measurement result is affected by the varied characteristics between the standard and the assayed samples. These characteristics may include the matrix material, sample geometry, density, material and shape of the container etc. Although most characteristics could be adapted to meet those of the standards, the chemical compositions of the assayed samples are still always different [4]. To get accurate results of the measurements it is essential to verify the effect of different factors against precise measurements in particularly self-absorption in the calculation of the activity of the considered samples. The main sources of uncertainty are differences in density between samples and standard sources. Different densities result in different self-correction factors and therefore, a correction in the efficiency curve is necessary [5]. Furthermore, when low-energy gamma emitters are presented in the sample, self-absorption effects within the sample become more significant. Factors like sample composition and sample size affect full energy peak efficiency (FEP) and, by extension, the precision in the determination of the activities [6]. The aim of this study is to investigate the effect of the difference in samples chemical composition on the response of a radiation detector using MCNP.

### II. MCNP Simulations

In this study, MCNP code was used to simulate the response of the detector when measuring nuclear material samples containing different compounds of uranium, plutonium and thorium with different densities (from 1 to 13 g.cm<sup>-3</sup>). These samples encased in aluminum cylindrical containers. The dimension of nuclear materials in the cans is 70 mm diameter and 20.8 mm height. Figure (1) shows the shapes and dimensions of the modeled sample and container. Table (1). Shows the used materials compounds in the study.

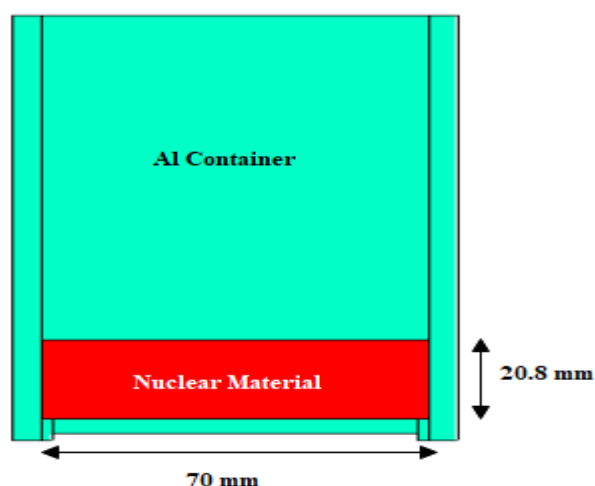

Figure (1). The Dimensions of the used NM samples in this study.

Table 1. Compounds of uranium, plutonium and thorium used in the study.

Uranium Compounds		Plutonium Compounds		Thorium Compounds	
Compound	Chemical form	Compound	Chemical form	Compound	Chemical form
Uranium Hydride	UH3	Plutonium Dihydride	PuH2	Thorium dihydride	ThH2
Uranium Nitride	UN	Plutonium Trihydride	PuH3	Thorium dioxide	ThO2
Uranium Diboride	UB2	Plutonium dioxide	PuO2	Thorium nitride	ThN3
Uranium Trinitrate	U2N3	Plutonium nitride	PuN	Thorium tetrafluoride	ThF4
Uranium Oxide	UO2	Plutonium oxide	PuO	Thorium disulphide	ThS2
Uranium Octa -Oxide	U3O8	Diplutonium trioxide	Pu2O3	Thorium tetrachloride	ThCl4
Uranium Trioxide	UO3	Plutonium Trifluoride	PuF3	Thorium sulphate nonahydrate	ThS2O17H18
Uranium Trifluoride	UF3	Plutonium tetrafluoride	PuF4	Thorium diselenide	ThSe2
Uranium Tetrafluoride	UF4	Plutonium hexafluoride	PuF6	Thorium tetraiodide	ThI4
Uranium Pentafluoride	UF5	Plutonium triiodide	PuI3		
Uranium Hexafluoride	UF6	Plutonium tribromide	PuBr3		
Uranyl Nitrate	UO2N2O6	Plutonium trichloride	PuCl3		
Uranium Trichloride	UCl3				
Uranium chloride	UCl4				
Uranium Hexachloride	UCl6				
Uranium Tetrabromide	UBr4				
Uranium Iodide	UI4				

The identification numbers of the materials (ZAIDs) were listed in the material card of the MCNP input file with their weight fractions. The library identifiers were selected such that detailed physics interactions treatment was considered. All samples were modeled with the same volume and configuration inside Al container. The used HPGe is a Microspec ORTEC with a relative efficiency of 40%. The detector was modeled according to the information provided by the manufacturer as illustrated in figure (2) [7]. Plane, cylinder and sphere surfaces were used to construct the detector body, hole, holder, cap and Beryllium window. The rounded

edges of the detector active volume and outer dead layer were constructed using combination of planes, cylindrical and tours surfaces.

The pulse height tally “F8” was considered to estimate the detected fraction of different gamma rays’ due different energies emitted from uranium, thorium and plutonium isotopes. These energies were selected to cove low, medium and high energy region Table (2) shows the selected energies for the study.

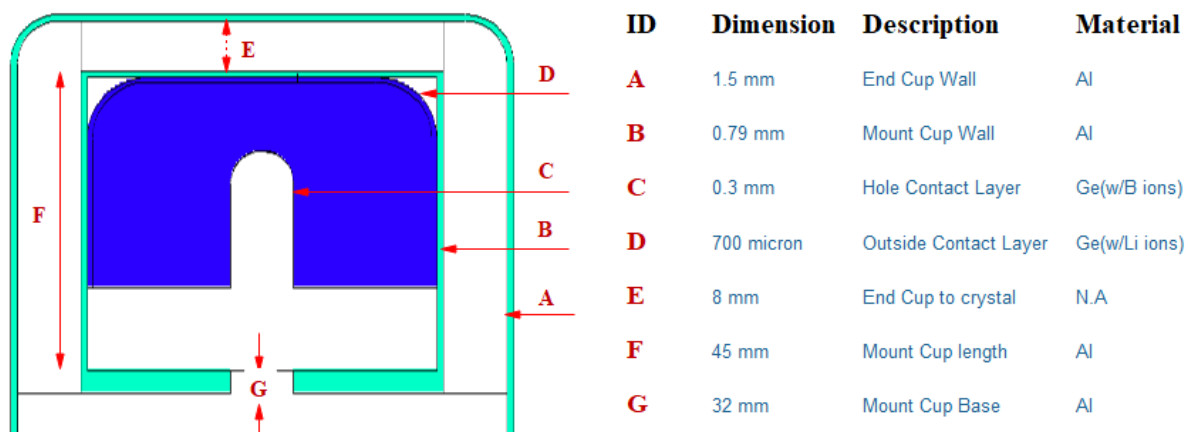

Figure (2). Manufacturer’s data for detector components, shape, materials and dimensions

Table (2) shows the selected energies for the study.

Thorium	Plutonium	Uranium
49.95 KeV	38.66 KeV	49.55 KeV
129.29 KeV	129.3 KeV	185.71 KeV
163.16 KeV	203.53 KeV	1001.1 KeV
320.8 KeV	658.9 KeV	

All calculations were performed with detector surface-to-nuclear material sample centre distance of 10 cm without using any collimators. The MCNP source distribution cards were used to define NM source in the samples Fig. 3 shows The MCNP detector and sample model, as drawn by the MCNP visual editor. The number of simulated histories was determined so as to keep the uncertainties in Mote Carlo calculations always better than 0.1%.

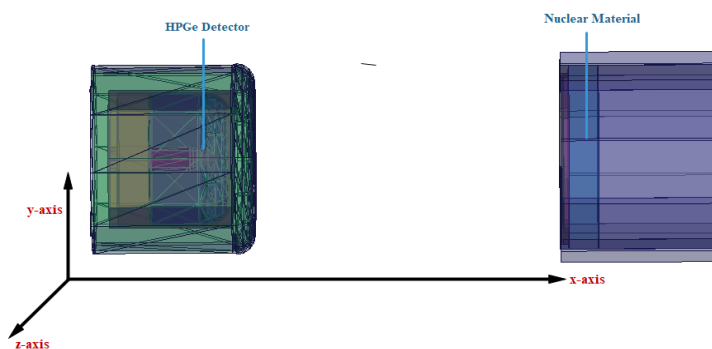

Figure (3). MCNP model for the used detector and sample under study.

### III. RESULT

Figures 4(a-c), 5(a-d) and 6(a-e) show the effect of different nuclear materials matrixes with different densities on the response of the HPGe detector. It was found that, when the atomic number in the nuclear material compound is gradually changed from small (Hydrogen, Z=1) to large (Iodine, Z=53), the detector response displays an increasing trend for low and medium energy ( $0 < \text{Energy} < 400$ ) KeV. On the contrary, the changes are minimal for high energies ( $> 600$  KeV) with changes in atomic number. As, the atomic number of Th, U and Pu are 90, 92, 94 respectively, the results in Figures 4, 5 and 6 show the same behavior but with different values in the detector count rate at constant density. The results show that the chemical composition of proposed nuclear material compounds’, exerts greater effects on the measurement of radionuclides emitting low-energy photons ( $< 100$  keV) in samples than those emitting high-energy photons. This phenomenon is most probably due to the more serious self-absorption of low-energy gamma rays; with increased energy, the self-

absorption weakens. An important finding in the results are that the sample with hydrogen reduces the detector response, which does not conform to the rules that a smaller atomic number of results in higher detection efficiency. The reason is that for all elements abundant in environmental matrices, the electron density is nearly constant except for H, which has a higher electron density and consequently a higher self-absorption probability.

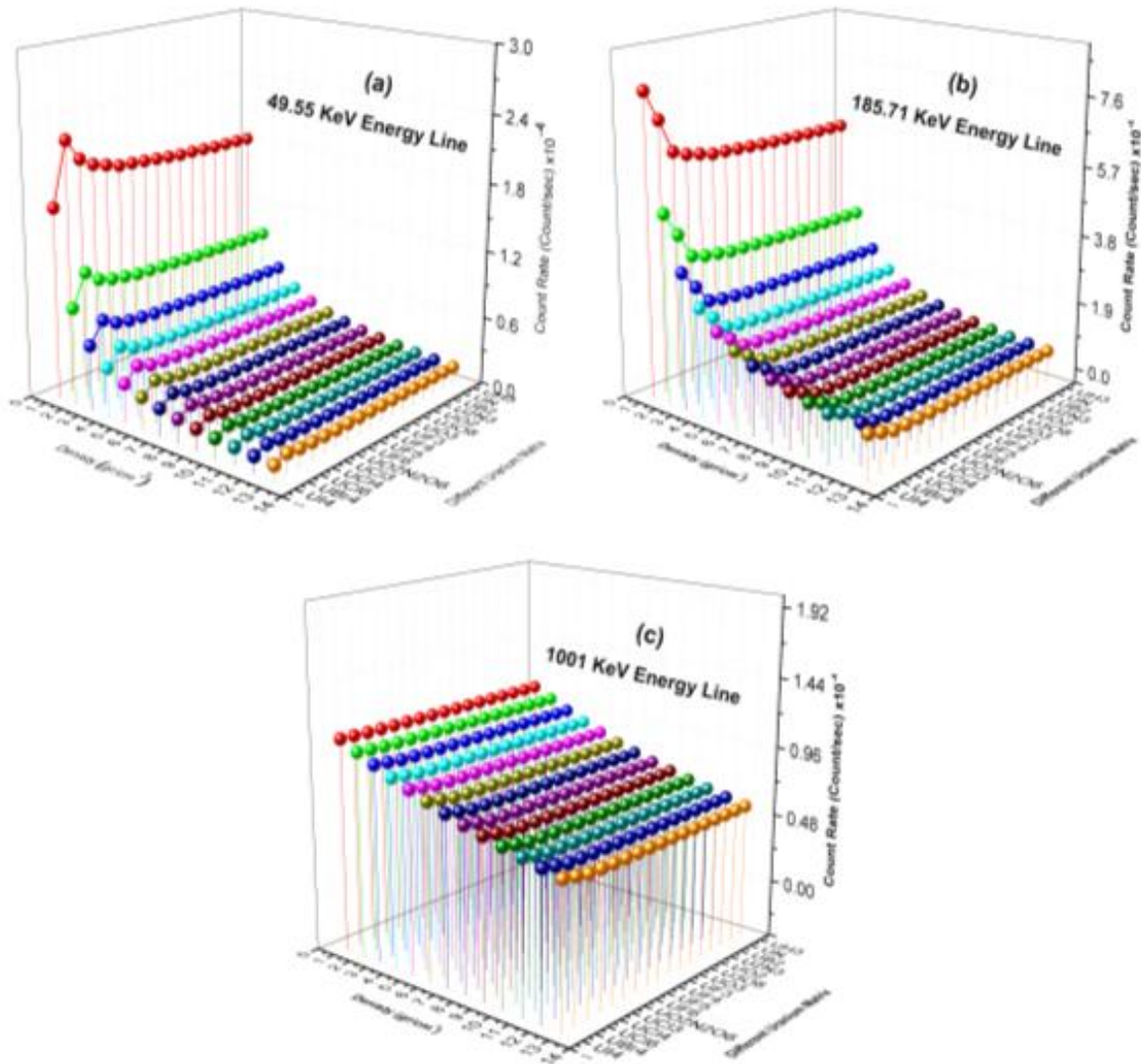

Figure.4(a-c). Plot of Count Rate due to 49.55, 185.71 and 1001KeV vs density and different uranium matrices.

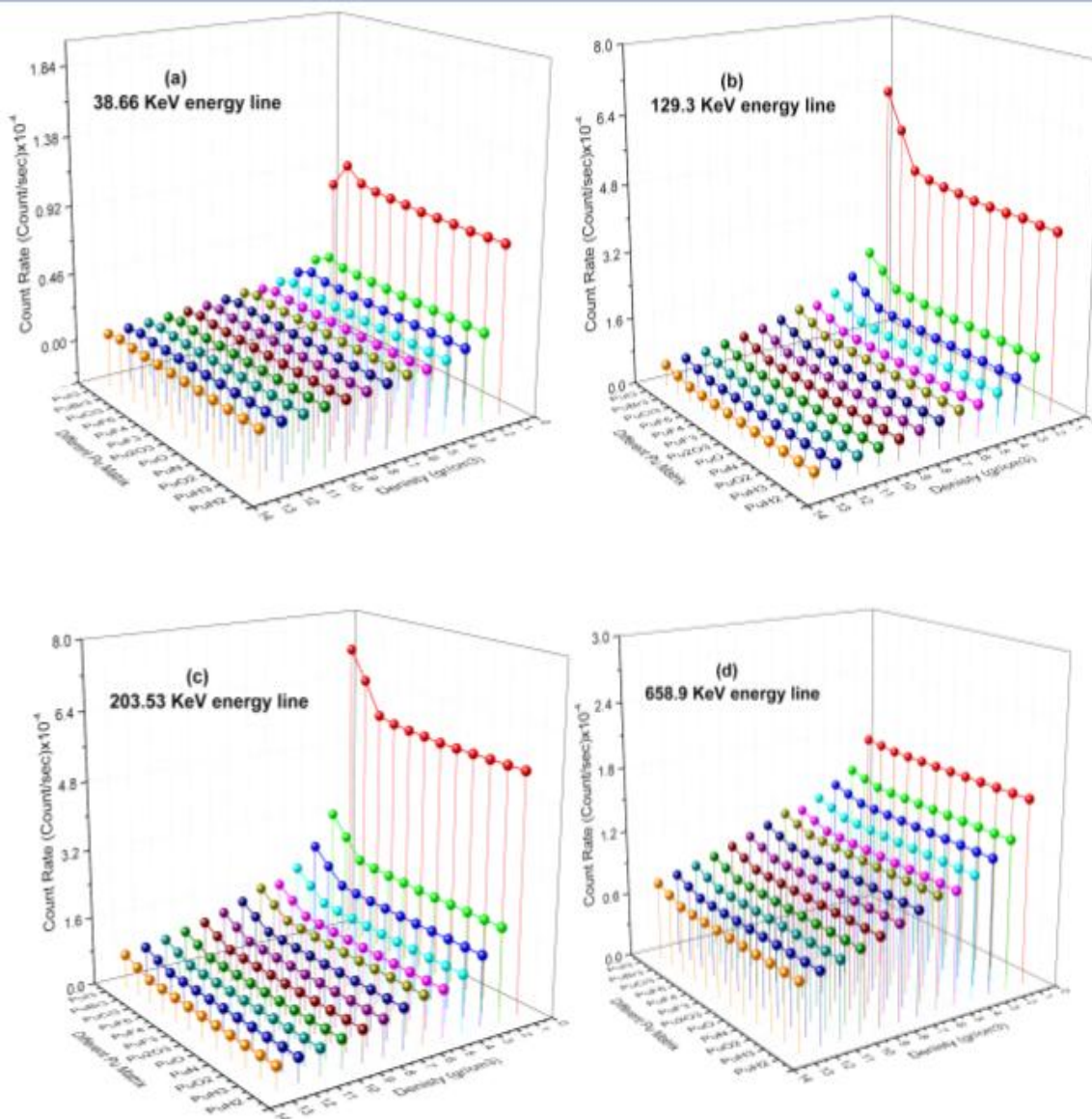

Figure.5(a-d). Plot of Count Rate due to 38.6, 129.3, 203.3 and 658.9KeV vs density and different plutonium matrixes.

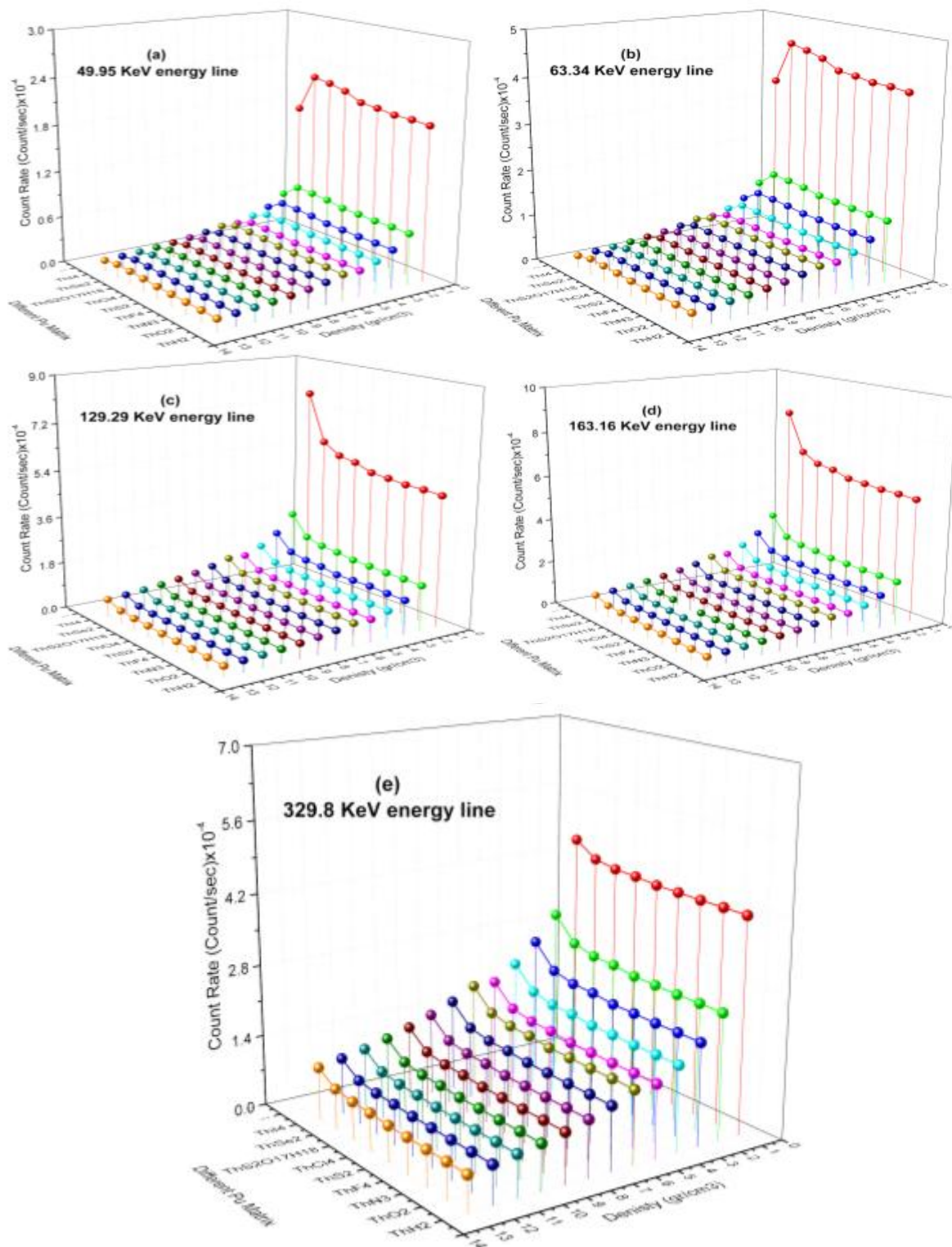

Figure.6(a-e). Plot of Count Rate due to 49.95, 63.34, 129.29, 163.13 and 329.8 KeV vs density and different thorium matrixes.

Figure (6) shows the effect of material density on the response of the HPGe detector.

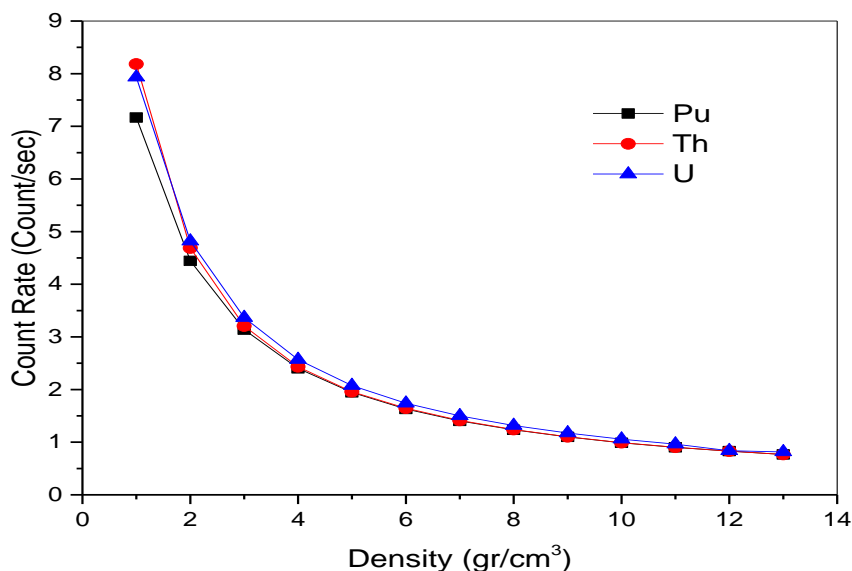

Figure.6. Density effect on the detector response.

#### IV. CONCLUSION

The effect of variation in the chemical compositions of different nuclear material compounds on the response of a HPGe detector is investigated. The Monte Carlo simulation technique is used to obtain the detector response due to different proposed samples. The samples were assumed to be identical except for chemical compositions and in densities. It is concluded that, the chemical composition of the sample plays an important role in response of the detectors for low and medium gamma energies, while at higher energies this effect can be neglected. For lower gamma energies, attenuation correction must be carried out in efficiency calibration due to the effect of the different in chemical compositions.

#### REFERENCE

- [1]. Nuclear Material Accounting Handbook, IAEA Services Series No. 15, May 2008,
- [2]. M. Ahmed and S. Shawky, Study on the performance of different uranium isotopic codes used in nuclear safeguards activities, *Heliyon* 5 (2019) e01470. doi: 10.1016/j.heliyon.2019.e01470,
- [3]. M. Ahmed, S. Shawky and Z. Ahmed, Effect of Detector Resolution on the Measurement of Nuclear Material Enrichment, *American Scientific Research Journal for Engineering, Technology, and Sciences (ASRJETS)* (2017) Volume 31, No 1, pp 201-206
- [4]. M. Darweesh, W. El-Gammal, A.A. Hamed, E.A. Badawi and Atef E. Ali, Characterization and Performance of A HPGe Detector For Nuclear Materials Verification, *Journal of Nuclear and Radiation Physics*, Vol. 9, No. 1&2 pp. 47-59, 2014
- [5]. Enrique R. González, Gabriela B. Grad, Edgardo V. Bonzi, Influence of the sample density in  $\gamma$ - spectrometry, *Applied Radiation and Isotopes* Volume 152, October 2019, Pages 86-90, <https://doi.org/10.1016/j.apradiso.2019.06.030>
- [6]. Hurtado, S., Villa, M., Manjn, G., Garca-Tenorio, R., 2007. A self-sufficient and general method for self-absorption correction in gamma-ray spectrometry using {GEANT4}. *Nucl. Instrum. Methods Phys. Res. Sect. A* <http://doi.org/10.1016/j.nima.2007.05.090>. <http://www.sciencedirect.com/science/article/pii/S0168900207009448>.
- [7]. W. El-Gammal, M. Darweesh , S. Shawky, Investigation of a dynamic measurement methodology for fast detection of gross defects in regularly distributed nuclear material samples, *Heliyon* 5 (2019) e02110, <https://doi.org/10.1016/j.heliyon.2019.e02110>

M. Darweesh. "Assessment of Matrix variation of Nuclear Materials bearing samples on gamma ray detectors response using MCNP code." *The International Journal of Engineering and Science (IJES)*, 9(5), (2020): pp. 38-44.