

A model for power losses reduction in low voltage distribution network of residential sectors.

Ganiyu A. Ajenikoko¹, Anthony A. Olaomi²

^{1,2} Department of Electronic & Electrical Engineering, Ladoko Akintola University of Technology, P.M.B. 4000, Ogbomoso, Nigeria.

-----ABSTRACT-----

This paper develops a mathematical model to assess the power factor in the households and investigates its impacts on the power losses in the low voltage distribution networks. Analysis of the power consumptions, the reactive power and the power factor of some household equipment were carried out using programmable computer aided measuring equipment.

The result of the research paper showed that improvement of power factor in the households significantly contributed in decreasing the power losses in the low voltage distribution networks.

KEYWORDS: Power losses, Low voltage, Distribution network, Active power, Reactive power, Power factor, Voltage Drop, House holds.

Date of Submission: 11 October 2014



Date of Publication: 05 November 2014

I. INTRODUCTION

The three main components of power systems are generation, transmission and distribution systems(Ciric et al 2003, Cespedes 2009). Distribution network consists of the primary distribution lines (33 Kv/11 Kv) and secondary distribution lines (415 volts line voltage). The high tension consumers and distribution transformers are fed by the primary distribution lines. The distribution transformers feed the low voltage distribution networks which are the secondary distribution lines(Ciric et al 2003). Low voltage distribution network is the last link connecting the consumers. Each of the primary distribution lines leave the sub-region as a three-phase circuit and supplies a number of distribution transformers. The secondary distribution lines are connected to the secondary side of the distribution transformers(John and Stephen 1994, Kersting 2001). The distribution system includes: the receiving station,the sub-transmission lines, distribution substation located closer to to the load center, secondary circuits on the low voltage side of the distribution transformer and service mains with metering arrangement(Balda 2007, Chen and Yang 2001)..

Most of the electrical loads consume reactive power in addition to the active power. The higher the reactive power transported by the distribution network to cover the load requirements, the lower will be the power factor. The ratio of the active power to the total apparent power of an electric network is the power factor. Low power factor has negative impacts on the electric distribution network represented in voltage and power losses as well as on the large consumers(Thunberg and Soder 2000, Kersting 2003)..

The major problem in the electricity sector is the high power losses. Losses result from technical and non-technical reasons. The non-technical losses result from theft, unpaid bills and any other illegal ways of accessing the network. Technical losses are the results of generation, transmission, distribution and operation systems(Hadi 2009,Meliopoulos et al 2008).

Measures for power factor improvement in Households.

In households, the following measures can be used to improve the power factor(Cheng and Shirmohammadi 2005, Baran and Wu 2009).

a Installation of proper variable capacitor at the main distribution boards of the individual residential buildings, where the PF will be improved for all households in the respective buildings.

- a. Installation of appropriate outdoor variable capacitor at the poles providing power to the house.
- b. Installation of compensation capacitors on the fluorescent lamps, since lighting represent a high percentage of the total daily load.
- c. Installation of capacitor with an appropriate size on the main circuit breaker of the house.
- d. Installation of a capacitor with proper size directly from the inductive equipment in the house to operate at the same time with it.

II. MATERIALS AND METHOD.

2.1. Development of mathematical model.

Consider a feeder supplied at the point A by a typical transformer as shown in Figure 1 below

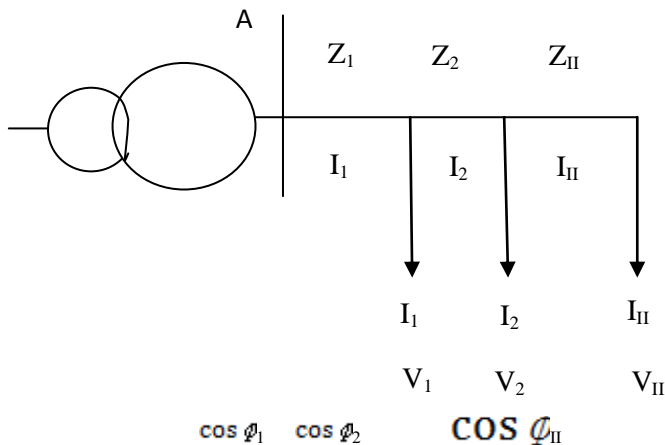

Let I_1, I_2, \dots, I_{11} , be the load current per consumer.

Z_1, Z_2, \dots, Z_{11} , the impedance of respective distribution length ($l_1, l_2, l_3, \dots, l_n$), $\cos \phi_1, \cos \phi_2, \cos \phi_{11}$, the power factor of each consumer.

$$Z_k = R_k + j X_k \quad (k = 1 \dots n) \quad (1)$$

The total active power losses in the distributor (ΔP) is computed as:

$$\Delta P = R_1 (I_1 + I_2 + \dots + I_n)^2 + R_2 (I_2 + I_3 + \dots + I_n)^2 + R_k (I_k + I_{k+1} + \dots + I_n)^2 + R_n I_n^2 \quad (2)$$

$$\Delta P = \sum_{k=1}^n R_k \left(\sum_{j=k}^n I_j \right)^2 \quad (3)$$

The load current (I_j) injected into a bus j is calculated as:

$$I_j = \frac{P_j}{V_j \cos \phi_j} \quad (4)$$

Substituting eq. (4) into eq. (3), we obtain

$$\Delta P = \sum_{k=1}^n R_k \left[\sum_{j=k}^n \frac{P_j}{V_j \cos \phi_j} \right]^2 \quad (5)$$

Where, n the number of buses in the distributor, V_j and P_j are voltage and power at bus j resp., R_k the resistance of the distributor branch K , $\cos \phi_j$ the power factor for j – load.

Eq. (5) shows that the power losses are inversely proportional to the power factor squared and the minimum losses ΔP_{\min} are obtained at $\cos \phi = 1$

$$\Delta P_{min} = \sum_{k=1}^n R_k \left(\sum_{j=k}^n \frac{P_j}{V_j} \right)^2 \quad (6)$$

Considering ΔP_{min} as a reference, we obtain the power losses in per unit ($\Delta P^* = \Delta P / \Delta P_{min}$):

$$\Delta p^* = \sum_{k=1}^n \frac{1}{\cos^2 \phi_j} \quad (7)$$

On other hand, voltage drop along the distribution network (Fig. 2) is obtain as :

$$\Delta V_j = |Z_j| \frac{P_j}{V_j \cos \phi_j} \quad (8)$$

The minimum voltage drop is achieved also when $\cos \phi_j = 1$. Taking this case as a reference we obtain the voltage drop per unit form (ΔV^*).

$$\Delta V_j^* = \frac{1}{\cos \phi_j} \quad (9)$$

Equation (9) represents the mathematical model for the voltage drop along the distribution network. It is inversely proportional to power factor at the individual bus.

Analysis of the power consumptions, the reactive power and the power factor of some household equipment such as lighting, refrigerator freezer, washing machine, television and satellite receiver, electric water heater, iron and small kitchen machines were carried out using programmable computer aided measuring equipment.

III. DISCUSSION OF RESULTS.

Figure 1 of case study 1 shows the relationship between the voltage drop and the power loss. The power loss increases as the voltage drop increases. At a voltage drop of 1.2V, the power loss was 1.12W while the voltage drop increases sharply to 2.8V with a corresponding power loss of 3.6W. Figure 2 shows how the power factor varies with voltage drop. The power factor is inversely proportional to the voltage drop. The voltage drop at a power factor of 0.5 was 2.1V. At a maximum power factor of 1.0000, the voltage drop declined appreciably to 2.8V. The relationship between the power factor and the power loss is shown in figure 3. These two parameters are inversely related. Thus, when the power factor was 0.5, the power loss became 2W. At maximum, the power factor was 1.0 which was accompanied by a corresponding least value of 1.11W. When the voltage drop increased from 1.3V to 1.5V, the power loss also increased from 1.17W to 1.35W while this is accompanied by a corresponding decrease in power factor from 0.7692 to 0.6667. This trend is maintained until a maximum power loss and voltage drop of 3.6W and 2.8V respectively were attained, even though the power factor has appreciably declined to 0.3571.

In the case study 2, figure 4 shows the relationship between the voltage drop and the power loss. The power loss varies linearly with the voltage drop. At a voltage drop of 1.5V, the corresponding power loss is 1.61W while the corresponding power loss to a voltage drop of 2V was 2.5W. The variation of power factor with the voltage drop is shown in figure 5. The power factor and voltage drop have an inverse relationship. The power factor was 0.6 when the voltage drop was 1.81V. The power factor falls rapidly from unity at a voltage drop of 1.1V to 0.44 at a voltage drop of 2.35V. Figure 6 shows how the power factor varies inversely with power loss. At a power factor of 0.7, the power loss was 1.61W while a power loss of 2.7W corresponds to a power factor of 0.48. The power factor was 0.9091 with a corresponding power loss of 1.12W.

Figure 7 of case study 3 shows the relationship between the voltage drop and the power loss. These two quantities have a linear relationship. As the voltage drop increases sharply from 1.0V to 2.001V, the power loss also increases from 1.1W to 1.81W. In figure 8, the relationship between the power factor and voltage drop is shown. The power factor increases sharply from 0.416 to 0.5 with a corresponding voltage drop from 1.22V to 1.38V. This trend is maintained until a power factor of 0.55 at peak is attained corresponding to a voltage of drop of 1.67V. The power factor declined sharply again until it attained a value of 0.492 with a corresponding voltage drop of 2.04V. The relationship between the power factor and the power loss for this case study 3 is also shown in figure 9. In this case, the power factor increases sharply from 0.408 to 0.556 at peak with a corresponding power loss increase from 1.34W to 1.58W. The power factor declines sharply to 0.494 at a power loss of 1.81W.

The power factor also decreased from 0.6494 to 0.5181 indicating that the power loss and the voltage drop are inversely proportional to the power factor. At maximum, the power loss was 3.31W with a corresponding voltage drop of 2.01V and a power factor of 0.4975.

In the case study 4, figure 10 shows the variation of the voltage drop with the power loss. The voltage drop increases linearly as the power loss. At a voltage drop of 1.5V, the power loss was 1.91W. The relationship between the power factor and the voltage drop is shown in figure 11. At maximum, the power factor was 0.64 with a corresponding voltage drop of 1.5V. After this peak value, the power factor decreases sharply until it attained a least value of 0.492 corresponding to a voltage drop of 2.01V. Figure 12 shows the relationship between the power factor and the power loss for the case study 4. The power factor increases from 0.446 to a peak value of 0.64 with a corresponding power loss increase from 1.3W to 1.59W. The power factor declines until it attained a least value of 0.492 with a corresponding power loss of 3.37W. At a power loss of 1.31W, the voltage drop was 1.10V with a power factor of 0.9091 indicating that the power factor was almost at a peak here even though the power loss and voltage drop were at minimum. The power loss increased to a maximum value of 2.03V at peak when of course, the power factor became drastically reduced to 0.4926 suggesting a very poor level of power factor which may obviously affect the performance efficiency of the system loads.

Case Study 2

The total consumed reactive power is high, thus leading to low power factor value, At constant active power, the load current increases with a corresponding decrease in the power factor, thus resulting in an increase in the power losses of the distribution network. This statement is in agreement with the mathematical model developed. The reduction in the power factor value is caused by the poor average power factor values measured separately for the main household equipment.

Case Study 1.

Case Study 1

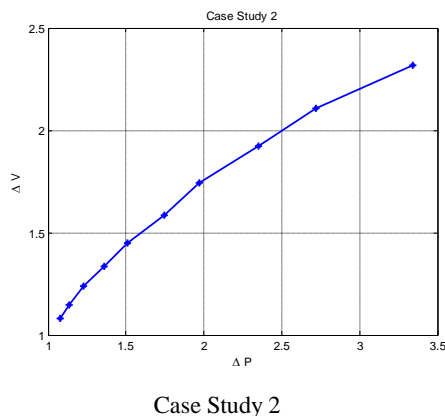

Figure 1: Voltage Drop versus Power Loss.



Figure 2: Power Factor versus Voltage Drop.

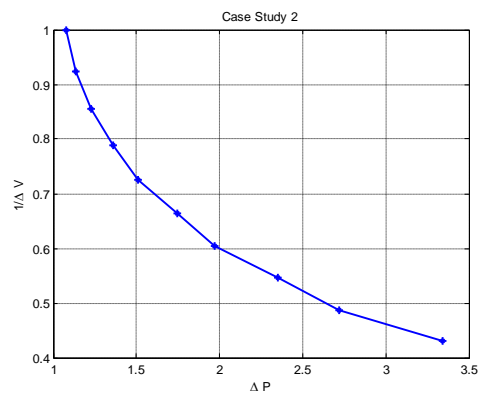

Figure 3: Power Factor versus Power Loss

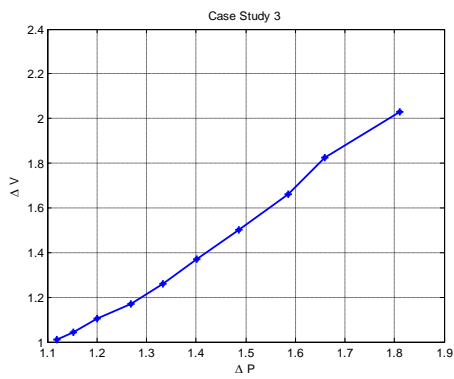

Figure 4: Voltage Drop versus Power Loss

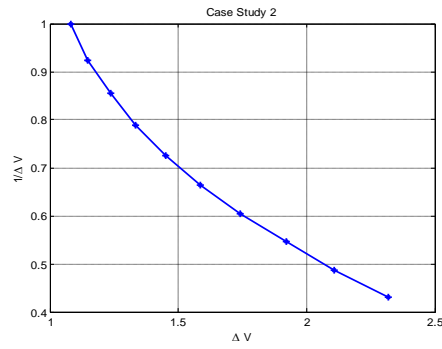

Figure 5: Power Factor Versus Voltage Drop.

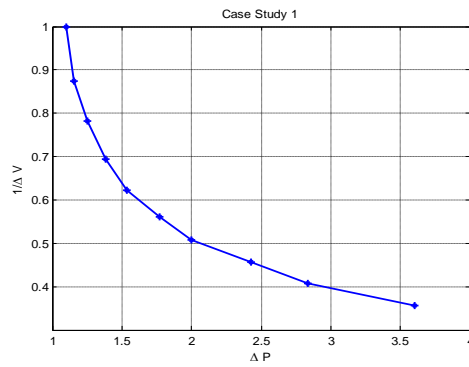

Figure 6: Power Factor versus Power Loss

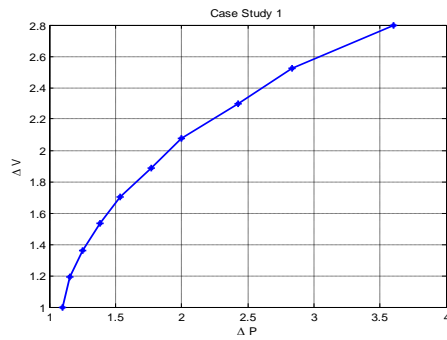

Figure 7: Voltage Drop versus Power Loss

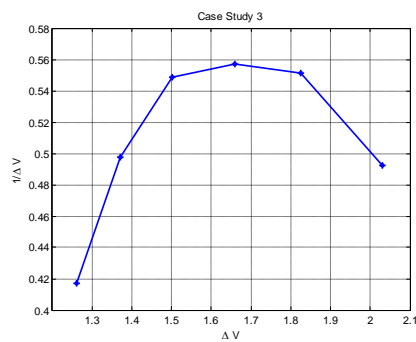

Figure 8: Power Factor versus Voltage Drop

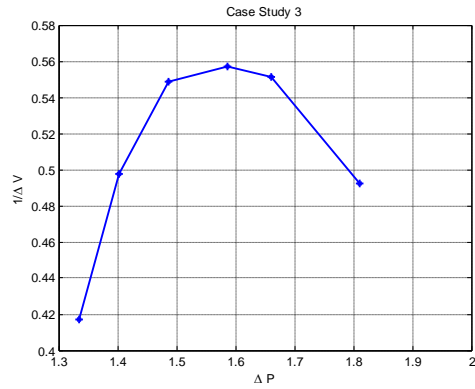

Figure 9: PF versus Power Loss

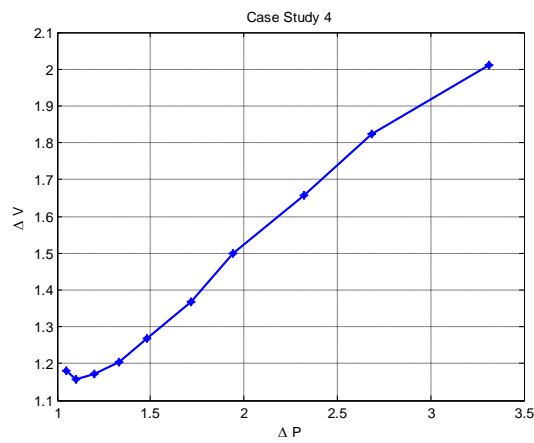

Figure 10: Voltage Drop versus Power Loss

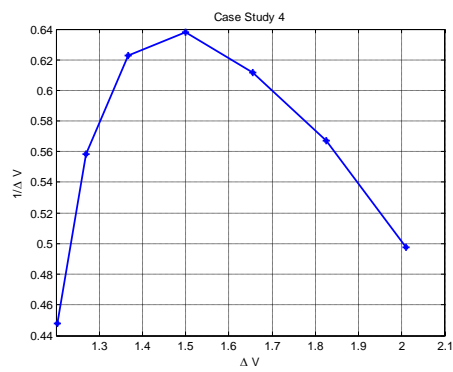

Figure 11: Power Factor versus Voltage Drop

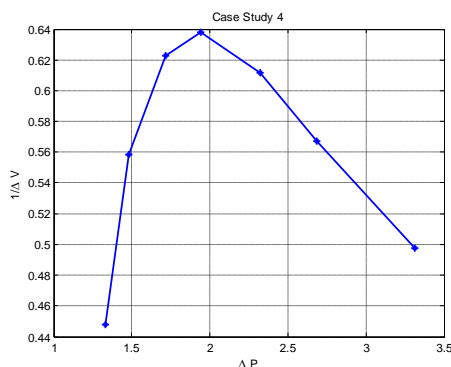

Figure 12: Power Factor versus Power Loss

IV. CONCLUSION

The result of the mathematical model showed that the power loss in the low distribution network is inversely proportional to the power factor squared. The power factor is low, since its average varies in the range: 0.57-0.77. The positive impacts of improving power factor in households on reducing the power losses in the low voltage distribution networks has been established.

REFERENCES

- [1]. Hadi S(2009):"Power System Analysis", McGraw-Hill Book Company, New York, Fourth Edition, Pp 112-126
- [2]. John J.G and Stephen J.R(1994):"Power Systems Analysis and Control", McGraw-Hill Book Company, New York, Third Edition, Pp 225-234.
- [3]. Meliopoulos A.P, Kennedy J, Nucci C.A and Contaxies(2008):"Power Distribution Practices and the impacts on Power Quality, Proceeding of 8th International Conference in Harmonic and Quality of Power, Pp 24-29.
- [4]. Balda J.C, Oliva A.R, McNabb D.W and Richardson R.D(2007):"Measurement of neutral currents and voltages on a distribution feeder", IEEE Trans. Power Delivery, Vol 12, No. 4,Pp 1799-1804.
- [5]. Chen T.H and Yang W.C(2001):"Analysis of Multi-grounded four-wire distribution systems considering the neutral grounding", IEEE Trans. Power Delivery, Vol. 16, No. 4, Pp 710-717.
- [6]. Thunberg E and Soder L(2000):"On the estimation of harmonic power losses in distribution systems", 9th International Conference on Harmonics and Quality of Power Proceedings, Pp 852-857.
- [7]. Ciric R.M, Padiha-Feltrin A.F and Ochoa L.F(2003):"Power flow in four-wire distribution Networks-General Approach", IEEE Trans. On Power Systems, Vol. 18, No, 4, Pp 1283-1290.
- [8]. Kersting W.H(2003):"The computation of neutral and dirt currents and power losses", IEEE-PES Transmission and Distribution Conference and Exposition Proceedings, Vol. 3, No. 6, Pp 978-983.
- [9]. Cheng C.S and Shirmohammad A(2005):"A Three- phase power flow method for real- time distribution system analysis", IEEE Trans on Power systems, Vol. 10, No. 2, Pp 671-769
- [10]. Kersting W.H(2001):"Radial distribution test feeders",IEEE Trans on Power systems, Vol. 6, No.3, Pp 971-985.
- [11]. Cespedes R(2009):"New method for the analysis of distribution networks", IEEE Trans on power systems, Vol. 5, No. 1, Pp 391-396.
- [12]. Baran M.E and Wu F.F(2009):"Network reconfiguration in distribution systems for loss reduction and load balancing", IEEE Trans. On Power Delivery, Vol. 4, No. 2, Pp 1401-1407.